

Data sheet | Item number: 231-605/018-000

1-conductor male connector; Snap-in mounting feet; 2.5 mm²; Pin spacing 5 mm; 5-pole

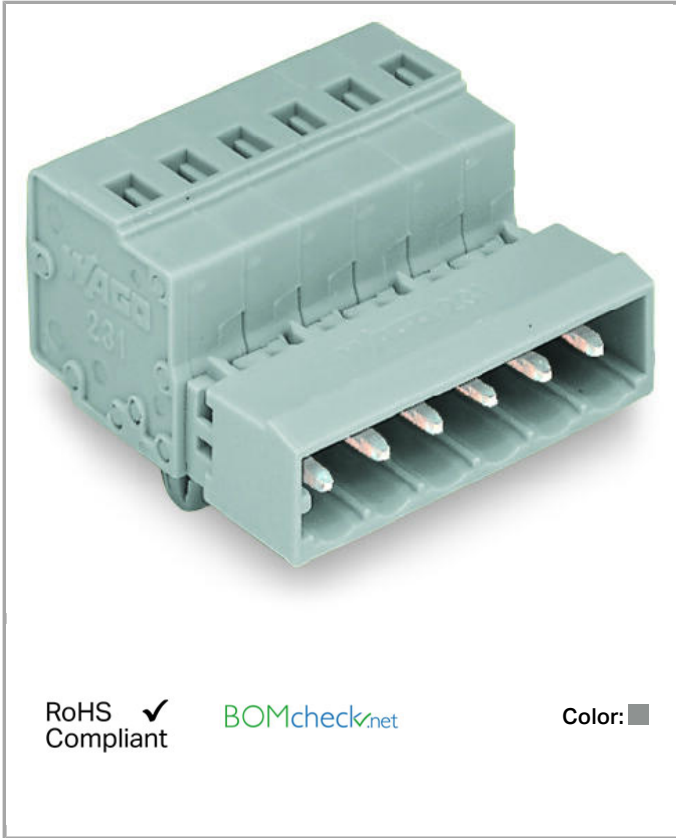

231-605/018-000



RoHS Compliant

[BOMcheck.net](https://www.bomcheck.net)

Color:

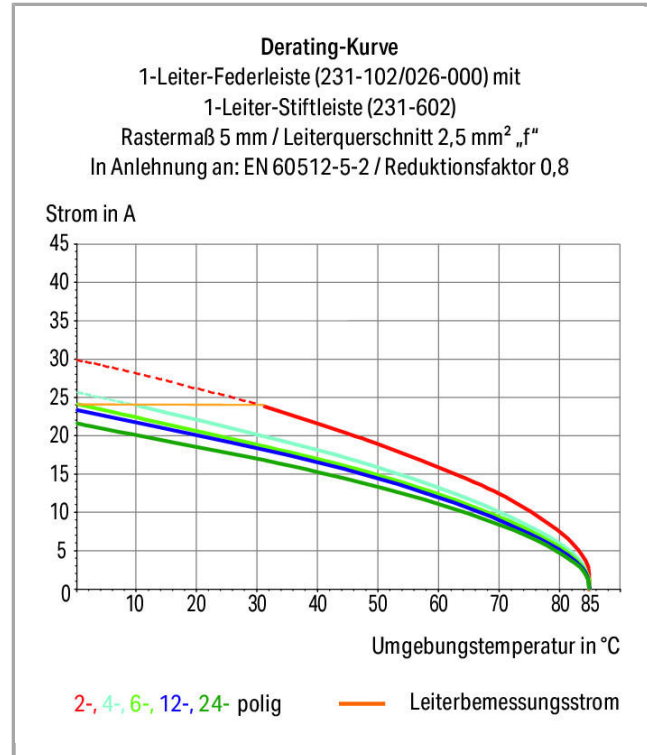

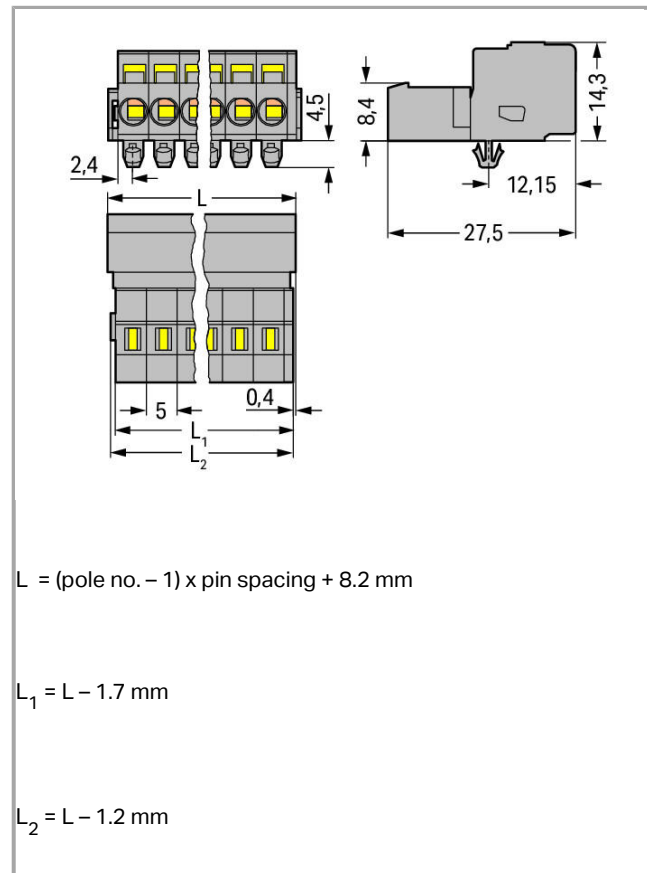

Item description

- Universal connection for all conductor types
- Easy cable pre-assembly and on-unit wiring via vertical and horizontal CAGE CLAMP[®] actuation
- For wire-to-wire and board-to-wire connections
- Versions available with snap-in mounting feet or flanges for panel or through-panel mounting
- With coding fingers

Safety information 1:

The *MULTI CONNECTION SYSTEM (MCS)* is designed without breaking capacity for compliance with DIN EN 61984. When used as intended, MCS Connectors shall not be connected/disconnected when live or under load. The circuit design should ensure header pins, which can be touched, are not live when unmated.

Data

Electrical data

Ratings per IEC/EN 60664-1

Rated voltage (III / 3)	320 V
Rated impulse voltage (III / 3)	4 kV



Rated voltage (III / 2)	320 V
Rated impulse voltage (III / 2)	4 kV
Rated voltage (II / 2)	630 V
Rated impulse voltage (II / 2)	4 kV
Rated current	12 A

Approvals per UL 1059

Rated voltage UL (Use Group B)	300 V
Rated current UL (Use Group B)	15 A
Rated voltage UL (Use Group D)	300 V
Rated current UL (Use Group D)	10 A

Approvals per UL 1977

Rated voltage per UL 1977 (factory wiring only)	600 V
Rated current per UL 1977 (factory wiring only)	15 A

Approvals per CSA

Rated voltage CSA (Use Group B)	300 V
Rated current CSA (Use Group B)	15 A
Rated voltage CSA (Use Group D)	300 V
Rated current CSA (Use Group D)	10 A

Connection data

Connection technology	CAGE CLAMP®
Actuation type	Operating tool
Solid conductor	0.08 ... 2.5 mm ² / 28 ... 12 AWG
Fine-stranded conductor	0.08 ... 2.5 mm ² / 28 ... 12 AWG
Fine-stranded conductor with ferrule with plastic collar	0.25 ... 1.5 mm ²
Fine-stranded conductor with ferrule without plastic collar	0.25 ... 2.5 mm ²
Strip length	8 ... 9 mm / 0.31 ... 0.35 inch
No. of poles	5
Total number of connection points	5
Total number of potentials	5
Number of connection types	1
Number of levels	1
Conductor entry direction to mating direction	0°

Geometrical Data

Pin spacing	5 mm / 0.197 inch
-------------	-------------------



Width	28.2 mm / 1.11 inch
Height	18.8 mm / 0.74 inch
Height from the surface	14.3 mm / 0.563 inch
Depth	27.5 mm / 1.083 inch

Mechanical data

Gehäuseblechstärke	0.6 ... 1.2 mm / 0.024 ... 0.047 inch
Mounting type	Snap-in mounting foot
Type of mounting	Panel mounting

Plug connection

Contact type (pluggable connector)	Male connector/plug
Connector connection type	for conductors
Mismating protection	No

Material Data

Color	gray
Material group	I
Insulating material	Polyamide 66 (PA 66)
Flammability class per UL94	V0
Clamping spring material	Chrome nickel spring steel (CrNi)
Contact material	Electrolytic copper (E _{Cu})
Contact plating	tin-plated
Fire load	0.145 MJ
Weight	8 g

Environmental Requirements

Limit temperature range	-60 ... +100 °C
-------------------------	-----------------

Commercial data



Product Group	3 (Multi Conn. System)
Country of origin	DE
GTIN	4044918257206
Customs Tariff No.	85366990990

Approvals / Certificates



Country specific Approvals

Logo	Approval	Additional Approval Text	Certificate name
	CB	IEC 61984	NL-39756



DEKRA Certification B.V.

	CSA DEKRA Certification B.V.	C22.2	1466354
	CSA DEKRA Certification B.V.	C22.2	1466354

Ship Approvals

Logo	Approval	Additional Approval Text	Certificate name
	ABS American Bureau of Shipping	-	14- HG1241537- PDA
	DNV GL Det Norske Veritas, Germanischer Lloyd	-	TAE000016Z

UL-Approvals

Logo	Approval	Additional Approval Text	Certificate name
	UR UL International Germany GmbH	UL 1977	E45171
	UR UL International Germany GmbH	UL 1977	E45171

Compatible products

Strain relief plate

Item no.: 232-605
Strain relief housing

232-605



assembling

**Item no.:** 209-137

Mounting adapter; can be used as end plate; 6.5 mm wide

209-137

Coding

**Item no.:** 231-129

Coding key; snap-on type

231-129

tools

**Item no.:** 209-130

Operating tool; suitable for 264, 280 and 281 Series; 1-way; of insulating material

209-130

**Item no.:** 209-132

Operating tool; for connecting comb-style jumper bar; 2-way; of insulating material

209-132

**Item no.:** 210-250

Operating tool; for female and male connectors with CAGE CLAMP® connection; MCS MIDI & MINI

210-250

**Item no.:** 210-657

Operating tool with partially insulated shaft; Blade (3.5 x 0.5) mm; short

210-657

**Item no.:** 210-720

Operating tool with partially insulated shaft; Type 2, blade (3.5 x 0.5) mm

210-720

**Item no.:** 231-131

Push-button; for female and male connectors; loose

231-131

**Item no.:** 231-159

Operating tool; for male and female connectors with CAGE CLAMP®; of Series 231, 232, 721, 722, 723, 731, 732

231-159

**Item no.:** 231-231

Combination operating tool; for male and female connectors with CAGE CLAMP®

231-231

**Item no.:** 231-291

Operating tool; for male and female connectors with CAGE CLAMP®; loose

231-291

**Item no.:** 280-432

Operating tool; of insulating material; 2-way

280-432

**Item no.:** 280-433

Operating tool; of insulating material; 3-way

280-433

**Item no.:** 280-434

Operating tool; of insulating material; 4-way

280-434

**Item no.:** 280-435

Operating tool; of insulating material; 5-way

280-435

**Item no.:** 280-436



















Operating tool; of insulating material; 6-way



















280-436











**Item no.:** 280-437

Operating tool; of insulating material; 7-way



280-437

	Item no.: 280-438 Operating tool; of insulating material; 8-way	280-438
	Item no.: 280-440 Operating tool; of insulating material; 10-way	280-440
Mounting adapter		
	Item no.: 209-148 Multi mounting adapter; for male and female connectors with snap-in mounting feet	209-148
ferrule		
	Item no.: 216-101 Ferrule; Sleeve for 0.5 mm ² / AWG 22; uninsulated; electro-tin plated	216-101
	Item no.: 216-102 Ferrule; Sleeve for 0.75 mm ² / AWG 20; uninsulated; electro-tin plated	216-102
	Item no.: 216-103 Ferrule; Sleeve for 1 mm ² / AWG 18; uninsulated; electro-tin plated	216-103
	Item no.: 216-104 Ferrule; Sleeve for 1.5 mm ² / AWG 16; uninsulated; electro-tin plated	216-104
	Item no.: 216-106 Ferrule; Sleeve for 2.5 mm ² / AWG 14; uninsulated; electro-tin plated	216-106
	Item no.: 216-121 Ferrule; Sleeve for 0.5 mm ² / AWG 22; uninsulated; electro-tin plated	216-121
	Item no.: 216-122 Ferrule; Sleeve for 0.75 mm ² / AWG 20; uninsulated; electro-tin plated	216-122
	Item no.: 216-123 Ferrule; Sleeve for 1 mm ² / AWG 18; uninsulated; electro-tin plated	216-123
	Item no.: 216-124 Ferrule; Sleeve for 1.5 mm ² / AWG 16; uninsulated; electro-tin plated	216-124
	Item no.: 216-131 Ferrule; Sleeve for 0.25 mm ² / AWG 24; uninsulated; electro-tin plated	216-131
	Item no.: 216-132 Ferrule; Sleeve for 0.34 mm ² / AWG 24; uninsulated; electro-tin plated	216-132
	Item no.: 216-141 Ferrule; Sleeve for 0.5 mm ² / 20 AWG; uninsulated; electro-tin plated; electrolytic copper; gastight crimped; acc. to DIN 46228, Part 1/08.92	216-141
	Item no.: 216-142 Ferrule; Sleeve for 0.75 mm ² / 18 AWG; uninsulated; electro-tin plated; electrolytic copper; gastight crimped; acc. to DIN 46228, Part 1/08.92	216-142
	Item no.: 216-143 Ferrule; Sleeve for 1 mm ² / AWG 18; uninsulated; electro-tin plated; electrolytic copper; gastight crimped; acc. to DIN 46228, Part 1/08.92	216-143
	Item no.: 216-144 Ferrule; Sleeve for 1.5 mm ² / AWG 16; uninsulated; electro-tin plated; electrolytic copper; gastight crimped; acc. to DIN 46228, Part 1/08.92	216-144

	Item no.: 216-151 Ferrule; Sleeve for 0.25 mm ² / AWG 24; uninsulated; electro-tin plated	216-151
	Item no.: 216-152 Ferrule; Sleeve for 0.34 mm ² / AWG 24; uninsulated; electro-tin plated	216-152
	Item no.: 216-201 Ferrule; Sleeve for 0.5 mm ² / 20 AWG; insulated; electro-tin plated	216-201
	Item no.: 216-202 Ferrule; Sleeve for 0.75 mm ² / 18 AWG; insulated; electro-tin plated	216-202
	Item no.: 216-203 Ferrule; Sleeve for 1 mm ² / AWG 18; insulated; electro-tin plated	216-203
	Item no.: 216-204 Ferrule; Sleeve for 1.5 mm ² / AWG 16; insulated; electro-tin plated	216-204
	Item no.: 216-221 Ferrule; Sleeve for 0.5 mm ² / 20 AWG; insulated; electro-tin plated	216-221
	Item no.: 216-222 Ferrule; Sleeve for 0.75 mm ² / 18 AWG; insulated; electro-tin plated	216-222
	Item no.: 216-223 Ferrule; Sleeve for 1 mm ² / AWG 18; insulated; electro-tin plated	216-223
	Item no.: 216-224 Ferrule; Sleeve for 1.5 mm ² / AWG 16; insulated; electro-tin plated	216-224
	Item no.: 216-241 Ferrule; Sleeve for 0.5 mm ² / 20 AWG; insulated; electro-tin plated; electrolytic copper; gastight crimped; acc. to DIN 46228, Part 4/09.90	216-241
	Item no.: 216-242 Ferrule; Sleeve for 0.75 mm ² / 18 AWG; insulated; electro-tin plated; electrolytic copper; gastight crimped; acc. to DIN 46228, Part 4/09.90	216-242
	Item no.: 216-243 Ferrule; Sleeve for 1 mm ² / AWG 18; insulated; electro-tin plated; electrolytic copper; gastight crimped; acc. to DIN 46228, Part 4/09.90	216-243
	Item no.: 216-244 Ferrule; Sleeve for 1.5 mm ² / AWG 16; insulated; electro-tin plated; electrolytic copper; gastight crimped; acc. to DIN 46228, Part 4/09.90	216-244
	Item no.: 216-262 Ferrule; Sleeve for 0.75 mm ² / 18 AWG; insulated; electro-tin plated; electrolytic copper; gastight crimped; acc. to DIN 46228, Part 4/09.90	216-262
	Item no.: 216-263 Ferrule; Sleeve for 1 mm ² / AWG 18; insulated; electro-tin plated; electrolytic copper; gastight crimped; acc. to DIN 46228, Part 4/09.90	216-263
	Item no.: 216-264 Ferrule; Sleeve for 1.5 mm ² / AWG 16; insulated; electro-tin plated; electrolytic copper; gastight crimped; acc. to DIN 46228, Part 4/09.90	216-264
	Item no.: 216-284 Ferrule; Sleeve for 1.5 mm ² / AWG 16; insulated; electro-tin plated; electrolytic copper; gastight crimped; acc. to DIN 46228, Part 4/09.90	216-284
	Item no.: 216-301 Ferrule; Sleeve for 0.25 mm ² / AWG 24; insulated; electro-tin plated	216-301

	Item no.: 216-302 Ferrule; Sleeve for 0.34 mm ² / 22 AWG; insulated; electro-tin plated	216-302
	Item no.: 216-321 Ferrule; Sleeve for 0.25 mm ² / AWG 24; insulated; electro-tin plated	216-321
	Item no.: 216-322 Ferrule; Sleeve for 0.34 mm ² / 22 AWG; insulated; electro-tin plated	216-322
Insulation stop		
	Item no.: 231-670 Insulation stop; 0.08-0.2 mm ² / 0.2 mm ² "s"	231-670
	Item no.: 231-671 Insulation stop; 0.25 - 0.5 mm ²	231-671
	Item no.: 231-672 Insulation stop; 0.75 - 1 mm ²	231-672
Jumper		
	Item no.: 231-902 Comb-style jumper bar; for 5 mm and 5.08 mm pin spacing; reduces conductor size to 1.5 mm	231-902
	Item no.: 231-903 Comb-style jumper bar; 3-way; suitable for 231 Series female connectors; with 5 mm pin spacing; insulated	231-903
	Item no.: 231-905 Comb-style jumper bar; 5-way; suitable for 231 Series female connectors; with 5 mm pin spacing; insulated	231-905
	Item no.: 231-907 Comb-style jumper bar; 7-way; suitable for 231 Series female connectors; with 5 mm pin spacing; insulated	231-907
	Item no.: 231-910 Comb-style jumper bar; 10-way; suitable for 231 Series female connectors; with 5 mm pin spacing; insulated	231-910
General accessories		
	Item no.: 231-668 Lockout caps; for covering unused clamping units	231-668
Marking accessories		
	Item no.: 210-331/500-103 Marking strips; as a DIN A4 sheet; MARKED; 1-12 (300x); Height of marker strip: 2.3 mm/0.091 in; Strip length 182 mm; Horizontal marking; Self-adhesive	210-331 /500-103
	Item no.: 210-331/500-104 Marking strips; as a DIN A4 sheet; MARKED; 13-24 (300x); Height of marker strip: 2.3 mm/0.091 in; Strip length 182 mm; Horizontal marking; Self-adhesive	210-331 /500-104
	Item no.: 210-332/500-202 Marking strips; as a DIN A4 sheet; MARKED; 1-16 (160x); Height of marker strip: 3 mm; Strip length 182 mm; Horizontal marking; Self-adhesive	210-332 /500-202
	Item no.: 210-332/500-204 Marking strips; as a DIN A4 sheet; MARKED; 17-32 (160x); Height of marker strip: 3 mm; Strip length 182 mm; Horizontal marking; Self-adhesive	210-332 /500-204



	<p>Item no.: 210-332/500-205 Marking strips; as a DIN A4 sheet; MARKED; 1-32 (80x); Height of marker strip: 3 mm; Strip length 182 mm; Horizontal marking; Self-adhesive</p>	<p>210-332 /500-205</p>
	<p>Item no.: 210-332/500-206 Marking strips; as a DIN A4 sheet; MARKED; 33-48 (160x); Height of marker strip: 3 mm; Strip length 182 mm; Horizontal marking; Self-adhesive</p>	<p>210-332 /500-206</p>
	<p>Item no.: 210-833 Marking strips; on reel; 6 mm wide; plain; Self-adhesive</p>	<p>210-833</p>
	<p>Item no.: 210-834 Marking strips; on reel; 5 mm wide; plain; Self-adhesive</p>	<p>210-834</p>

Downloads

CAD/CAE - Smart Data

CAD data

3D Download 231-605/018-000	URL	Download

Subject to changes.